

INOX STANDARD FILTER HOUSING

SFH-SPC-5

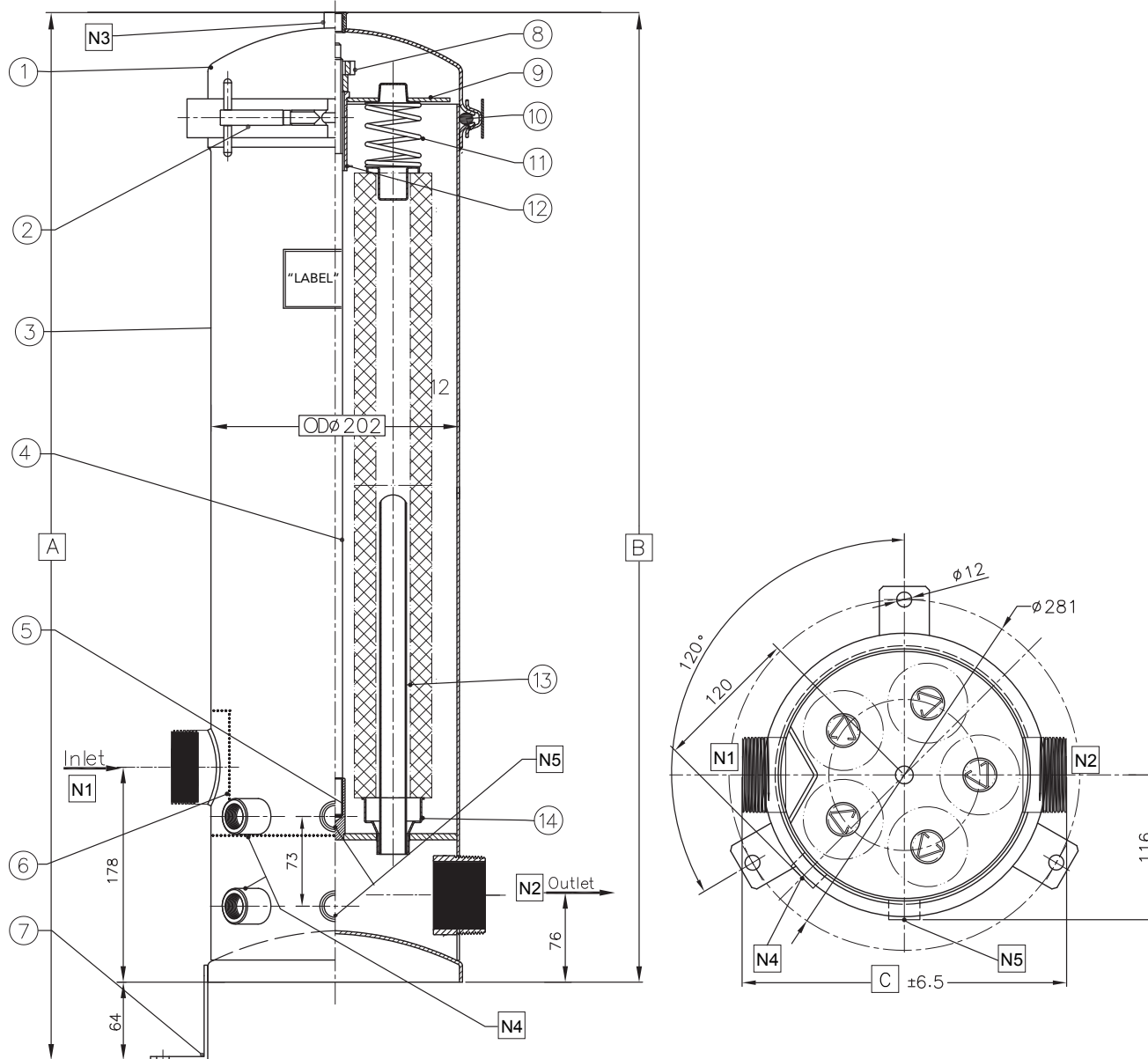

Overall Dimensions			
To Accommodate Filter Qty x Length	A mm	B mm	C mm
5 x 10"	603	539	260
5 x 20"	857	793	260
5 x 30"	1111	1047	260
5 x 40"	1365	1301	260

Port Details					
No.	Type	Size	No.	Type	Size
N1	Inlet	2" BSPT-M	N4	Drain (x2)	1/2" BSPT-F
N2	Outlet	2" BSPT-M	N5	Gauge (x2)	1/4" BSPT-F
N3	Vent	1/4" BSPT-F			

Components					
No.	Name	Material	No.	Name	Material
1	Lid	316L	8	Tightening Knob	316L
2	V-Clamp	304	9	Hold Down Plate	316L
3	Body	316L	10	O-Ring	BUNA-N
4	M12 Tie Rod	316L	11	Cartridge Locator Spring (x5)	316L
5	Tie Rod Retainer	316L	12	Guide Bushing	316L
6	Baffle Plate	316L	13	V Post (x5)	316L
7	Legs (x3)	304	14	Cartridge Cup Adaptor Plate	316L

Technical Information	Maximum Operating Temperature	120°C
<ul style="list-style-type: none"> Pressure relief device should be installed on the outer piping by the customer to assure that pressure in the vessel can not exceed the design pressure indicated Vent and gauge ports are fitted with 316L PTFE taped plugs All dimensions are approximate in mm 	Design Pressure	10 bar
	Hydrostatic Test Pressure	10 bar